

MANUAL – INSTALLATION + SERVICE

Power and Control Module

Interior and Perimeter Zones Cooling and Heating – IZ2 & PZ1

v100 – Issue Date: 02/12/24

© 2024 Price Industries Limited. All rights reserved.

PRICE[®]

PCM - INTERIOR AND PERIMETER ZONES COOLING AND HEATING

TABLE OF CONTENTS

Product Overview

Introduction.....	1
General Safety Guidelines.....	1
Safety Precautions	1
Safety Symbols	1
Underfloor Systems Control Zones.....	2
General Description.....	3
Features of the PCM	4
Operation.....	4

Installation & Mounting Instructions

Installation.....	5
Price Flow Response Chart	5
Input/Output Description	6
Wiring	7
Thermostat Installation	8
How to use Thermostats	9

Display Navigation

Initial Startup	10
Service Menu	11
Balancing Menu	12
VVT Menu	13
Setpoint Menu.....	14
Input Menu.....	15
Output Menu - Aux Binary.....	16
Output Menu - Analog Outputs	17
Stat Setup Menu	18
Info Menu.....	19
Address Menu.....	20

Networking & Setup

BACnet Networking and Setup	21
Setting the Device Instance	26
LINKER - USB Service Tool	27

Maintenance

Troubleshooting.....	28
Hardware Specifications.....	29

PCM - INTERIOR AND PERIMETER ZONES COOLING AND HEATING

PRODUCT OVERVIEW

Introduction

In this manual, you will find technical descriptions and diagrams of underfloor system components along with their installation instructions. Practical guidelines and recommendations are also provided. If more information is required about this equipment, please contact a Price sales representative.

General Safety Guidelines

This document is intended for use by owner-authorized operating/service personnel who are expected to possess the required training to enable them to perform their tasks properly and safely. This individual must have read and understood this document and any referenced materials prior to performing any task on this equipment. Also, it is essential that this individual be familiar with and comply with all applicable governmental standards and regulations pertaining to the task in question. This individual must also verify that installation and connections comply with local building codes. It is the obligation and responsibility of the operating/service personnel to identify and recognize these inherent hazards, protect themselves, and proceed safely in completing their tasks. Failure to comply with any of these requirements could result in severe personal injury or death to themselves and people at the site, as well as serious damage to the equipment and the property in which it is situated.

The equipment discussed in this manual is relatively complicated apparatus and must be handled with the necessary precautions. Individuals may be exposed to certain components or conditions such as refrigerants, oils, materials under pressure, rotating components, and both high and low voltage during installation, operation, maintenance or service of this equipment. If misused or mishandled, each item has the potential to cause bodily injury or death.

Safety Precautions

When using electrical appliances, basic safety precautions should always be followed including the following:

1. Read all instructions.
2. Do not touch hot surfaces.
3. To protect against electrical shock do not immerse cord, plugs, or Control Box in water or other liquids.
4. Unplug the unit when not in use and before cleaning.
5. Do not operate any appliance with a damaged cord or plug or after the appliance malfunctions or has been damaged in any manner. Return appliance to the nearest authorized service facility for examination, repair or adjustment.
6. The use of accessory attachments not recommended by the appliance manufacturer may cause injuries.
7. Do not use outdoors.
8. Do not let cord hang over edge of a table or counter, or touch hot surfaces.
9. Do not place on or near a hot gas or electric burner, or in a heated oven.
10. Always attach plug to appliance first, then plug into the power source. To disconnect, turn any control to "off", then remove plug from power source.
11. Do not use appliance for other than intended use.
12. Save these instructions.

Safety Symbols

The following symbols are used in this document to alert the reader to areas of potential hazard:



Failure to observe may result in personal injury, death or equipment damage.



Failure to observe may result in equipment damage.

NOTE: Used to highlight additional information helpful to the reader.

PCM - INTERIOR AND PERIMETER ZONES COOLING AND HEATING

PRODUCT OVERVIEW

Underfloor Systems Control Zones

INTERIOR ZONES

Constant Air Volume - Cooling Only

Typically, interior zones have relatively stable loads hence constant volume supply is often employed. A typical interior zone consists of constant volume or constant pressure turbulent floor twist outlets installed in a large, common plenum space. In this method the entire plenum space is treated as one zone and, under fluctuating loads, the amount of air delivered to the space is regulated by the relative pressure in this plenum, modulated by a single point of control. Manual face-adjustable diffusers (MFD) provide occupant control of airflow volume.

Variable Air Volume - Cooling Only

In the case an open plenum is desired to be divided into several zones, variable air volume control is possible with the use of devices installed under the diffuser or with the use of a variable volume basket. The variable volume diffusers would be controlled by the PCM. The PCM would open and close the diffusers releasing air from the pressurized plenum. The variable volume (VAV) diffusers require a 24 VAC signal which is provided by the PCM to modulate the actuators. Meanwhile, the PCM accepts a 0 to 10 VDC cooling signal either from a manual control signal or from a thermostat. The PCM modulates the airflow from 0% to 100%.

PERIMETER ZONE

Trough Heating and Cooling

Use of linear floor grilles with integrated heating elements offer a system with heightened flexibility and efficiency as it omits the use of fan terminal units and ducting. In cooling mode, dampers on the LFGH modulate open to the plenum allowing more airflow into the space to satisfy the cooling demand. When a call for heat arises, the hot water or electric coil energizes and the diffusers either open to the plenum or to a perimeter cavity to allow air to pass over the heating element. LFGHs are controlled by the PCM where up to 12 LFGHs can be daisy chained.

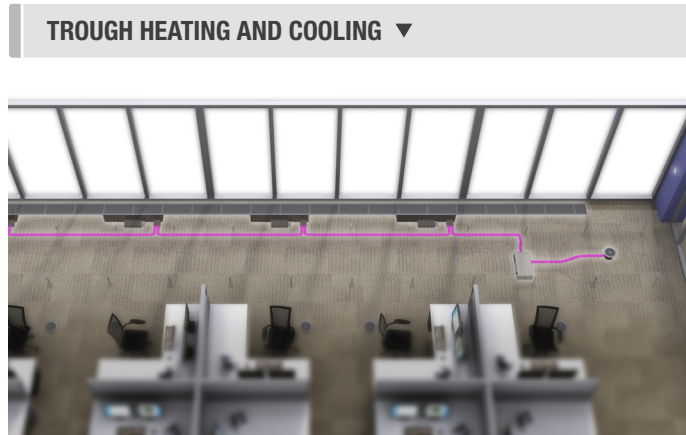
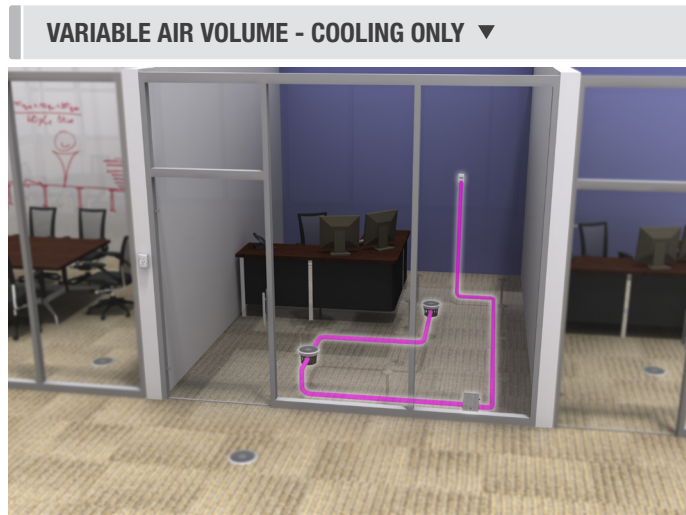

PCM - INTERIOR AND PERIMETER ZONES COOLING AND HEATING

PRODUCT OVERVIEW

General Description

The Power and Control Module (PCM) for interior and perimeter cooling and heating control is a direct digital controller for pressurized underfloor plenum cooling zones. It can control up to 30 daisy chained underfloor damper/diffusers – 12 of which can be perimeter units with integrated heat connected using plug-and-play CFLEX cables. Auxiliary inputs and outputs add to the PCM's flexibility.

The PCM offers cutting edge zone control by combining the accuracy of direct digital control with the flexibility of an individual zone control system; providing maximum control and efficiency. An advanced and configurable proportional integral controller allows for exceptional user comfort and energy efficiency. Installation of the controller and thermostat is simple and error proof with RJ-45 (network type) connections to the thermostat and BACnet network.

PCM comes as a rugged galvanized enclosure complete with a 100VA transformer and disconnect switch.

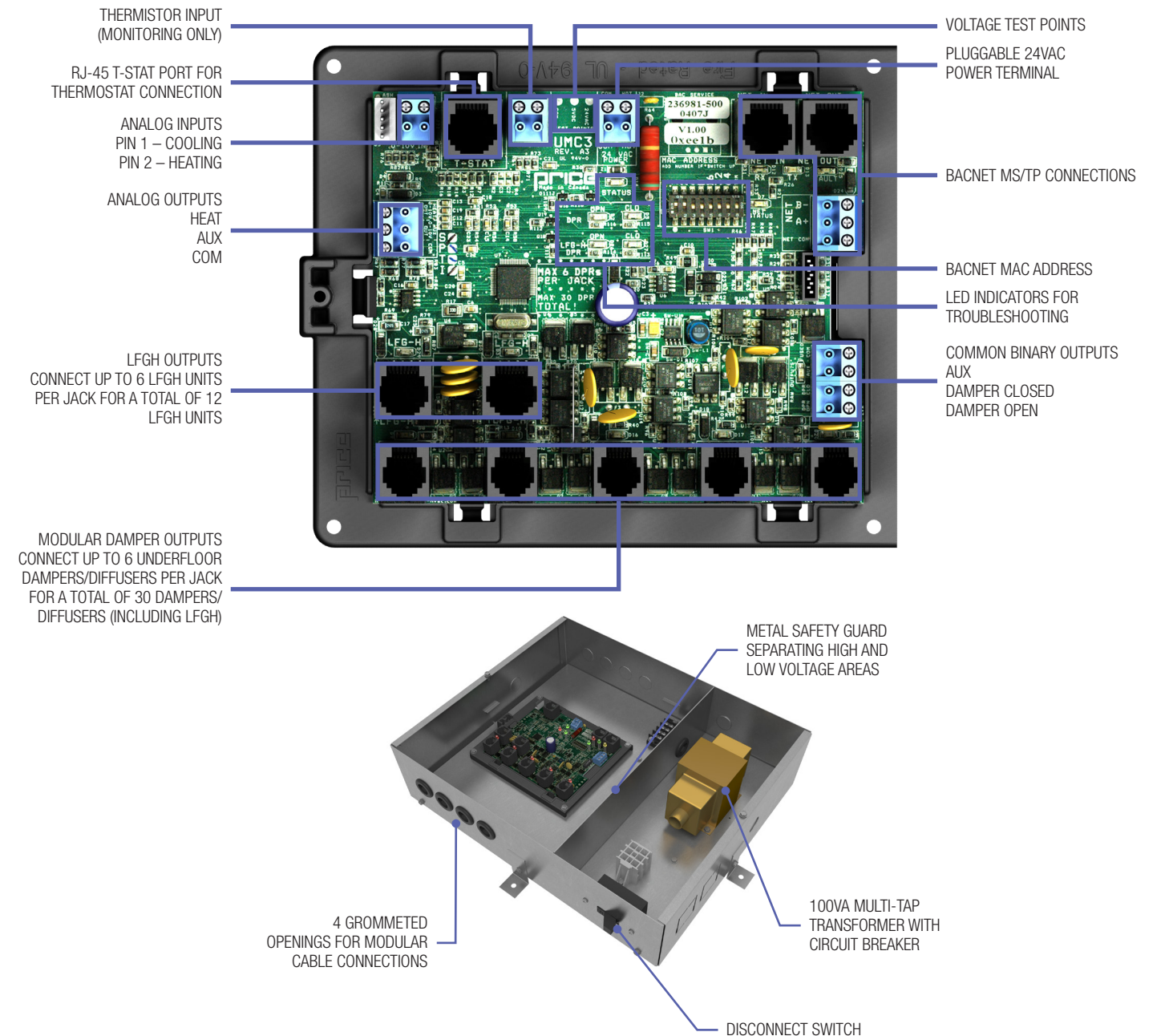

PCM - INTERIOR AND PERIMETER ZONES COOLING AND HEATING

PRODUCT OVERVIEW

Features of the PCM

- Control up to 30 underfloor dampers.
- Modular connections to dampers – Use RJ-12 cables included with dampers to connect underfloor dampers to PCM. LFGH dampers use RJ-45 connections.
- Outputs protected by self-resetting thermal fuses – Prevents damage to circuit board in the event of a damaged cable. Fault LED lights when dampers are trying to drive on an output with damaged cable.
- Auxiliary 24VAC Binary Output – Use for reheat, room lights, signal to other equipment, etc. Rated for a maximum output of 0.5A (12VA).
- Auxiliary Analog Outputs (2) – Use to connect to other equipment, BAS, etc. Output range fully configurable (2-10VDC, 0-10VDC, 10-2VDC, etc.). Rated at a maximum output of 10mA each.
- Analog Inputs (2) – Configurable to allow control of the PCM from a source other than a Price Thermostat (BAS, third party thermostat, etc.). Accepts the standard dual 0-10VDC signal for cooling/heating. (if not using LFGH or other heaters connected to PCM, only the 0-10V cooling signal is needed).
- Input (1) 10K type J thermistor – Can be used to monitor a temperature over the network. Can also be used for heat/cool changeover.
- Thermostat port - For RJ-45 connection to thermostat from the PCM controller.
- Native BACnet MS/TP communication – Connect using RJ-45 cable, or use discrete twisted-pair wire to terminal block. Available speeds: 9600, 19200, 38400, 76800 (default).
- LED Indication – For ease of troubleshooting – displays status, damper directions, BACnet status, and output fault.
- Pluggable terminal blocks – For easy installation.
- High-Voltage disconnect switch.
- Max 100VA multi-tap transformer with circuit breaker.
- Metal safety guard separating high and low voltage areas.
- 4 grommets openings for modular cable connections.
- Temperature sensor input (for monitoring).
- Disconnect switch.
- Pluggable 24VAC power terminal.

Operation

The PCM controller is an advanced and fully configurable underfloor ModuFlex cooling controller. It is typically interfaced with one of four Price Thermostats to determine room load and allow for setup functions. With a variety of output configurations, the PCM can control up to 30 underfloor dampers, as well as auxiliary equipment using its auxiliary 24VAC binary outputs, and analog 0-10V outputs.

Upon an increase in space temperature the controller regulates the dampers open to increase the flow of cool air. On an increase of space temperature greater than the proportional band, the dampers' positions are maintained at their pre-selected maximum setting.

On a decrease in space temperature the controller regulates the dampers closed to decrease the flow of cool air. If connected to LFGH floor grills with integrated damper and reheat, the PCM will energize or modulate the heat proportionally to the room demand. If the space temperature decreases to less than the proportional band, the dampers' positions are maintained at their pre-selected minimum setting.

The PCM can also be configured to accept 0-10V input signals from a BAS system or third party thermostat for room load calculations, instead of data from the thermostat.

The PCM can be used as a stand alone unit, or can be interfaced into a BAS with the MS/TP BACnet network.

The PCM offers five thermostat options that provide a range of control from room temperature sensing, all the way to motion sensing. With the use of the LCD Thermostat, balancing and system setup can be achieved. Further, with the use of the LCD Thermostat with Motion, the PCM can be used as a motion-occupied zone and lighting controller. The LCD Thermostat with Motion offers different levels of sensitivity and still performs all the functions of the regular LCD Thermostat.

PCM - INTERIOR AND PERIMETER ZONES COOLING AND HEATING

INSTALLATION & MOUNTING INSTRUCTIONS

Installation

1. Before installation, make sure that Building installation should have maximum of 20 A Circuit Breaker.
NOTE: PCM doesn't contain any primary Protection and entirely relies on protection from Building Installation.
2. Place the PCM in the underfloor plenum in the center of the controlled zone.
3. Supply power and ground to terminal per wiring diagram.
NOTE: This task must be completed by a certified and licensed electrician.
4. Connect underfloor dampers using CFLEX cables supplied with dampers. Follow these general rules:
 - A. Connect no more than 30 dampers total
 - B. Daisy chain up to 6 dampers per output – no more
 - C. Do not connect standard dampers (with RJ-12 plug) to LFGH outputs (which use RJ-45 plug)
 - D. LFGH dampers (up to 12) count towards the maximum of 30 dampers per controller
5. Run CFLEX thermostat cable to thermostat, and plug into "T-Stat" port on the PCM. (For thermostat installation reference the Installation & Mounting Instructions Thermostat Installation section.)
6. Connect BACnet network (if used). For more detailed information on networking with PCM reference the Display Navigation Address Menu section.
7. Flip the PCM's power switch to the ON position.

Price Flow Response Chart

HCCO Response		Cooling Min		Cooling Flows		Heating Min		Heating Flows		Neutral Supply Air Flow	
PI = Cooling	Supply air = Cold			D	L						
PI = Heating	Supply air = Cold					D		L			
PI = Neutral	Supply air = Cold	D	L								
PI = Cooling	Supply air = Hot	D	L								
PI = Heating	Supply air = Hot							D	L		
PI = Neutral	Supply air = Hot	D	L								
PI = Cooling	Supply air = Neutral									D	L
PI = Heating	Supply air = Neutral					D		L			
PI = Neutral	Supply air = Neutral									D	L

"D" indicates the target of the regular dampers and "L" represents the target of the LFGH dampers (with integrated reheat)

NOTE 1: By default the PCM is shipped configured for **cold supply air only**. This can be changed to enable HCCO with thermistor probe (however this will almost never be the case).

NOTE 2: PI = Proportional Integral = room load (either cooling/neutral/heating)

Above is a flow response chart for the PCM, showing the demand, duct air condition, and the controller's output.

E.g.: PI = Cooling, Supply Air = Cold, Output = Cooling Flows. This indicates that the room demand is in cooling, the supply air is cold, and the controller would modulate both the regular dampers and the LFGH dampers between the Cool Min and Cool Max values.

TECH TIP ▼

Use the above table to determine what airflows are being chased in certain modes. Example: If PCM is trying to heat the room (PI = Heating) and cool air is being supplied (Duct Air = Cold) it will chase its heating min flow.

PCM - INTERIOR AND PERIMETER ZONES COOLING AND HEATING

INSTALLATION & MOUNTING INSTRUCTIONS

Input/Output Description

24VAC Binary Outputs	Description
BO – DPR OPN	Plenum damper open. Used for floating point actuators.
BO – DPR CLO	Plenum damper closed. Used for floating point actuators.
BO – AUX	Aux binary output available.
Analog Outputs	
AO – Heat	Signal sent to LFGH diffusers (0-10VDC)
AO – Aux	Aux analog output available (0-10VDC)
Analog 0-10VDC Inputs	
AI4 – Cooling	Can be configured (along with AI5) to control the PCM from a third party thermostat. In this configuration, AI4 is the 0-10VDC cooling load input. Can also be used for simple voltage monitoring when analog inputs are not configured as control source.
AI5 – Heating	Can be configured (along with AI4) to control the PCM from a third party thermostat. In this configuration, AI5 is the 0-10VDC cooling load input. Can also be used for simple voltage monitoring when analog inputs are not configured as control source.
Additional Inputs	
AI1 – 5VDC Sensor	Typically used for voltage monitoring over BACnet network.
THERM	Analog Input for temperature probe hookup with 10k Type J Thermistor. Typically used for temperature monitoring over BACnet network. Can also be configured for heat/cool changeover if required.

PCM - INTERIOR AND PERIMETER ZONES COOLING AND HEATING

INSTALLATION & MOUNTING INSTRUCTIONS

Wiring

Below is an example of a typical PCM layout.

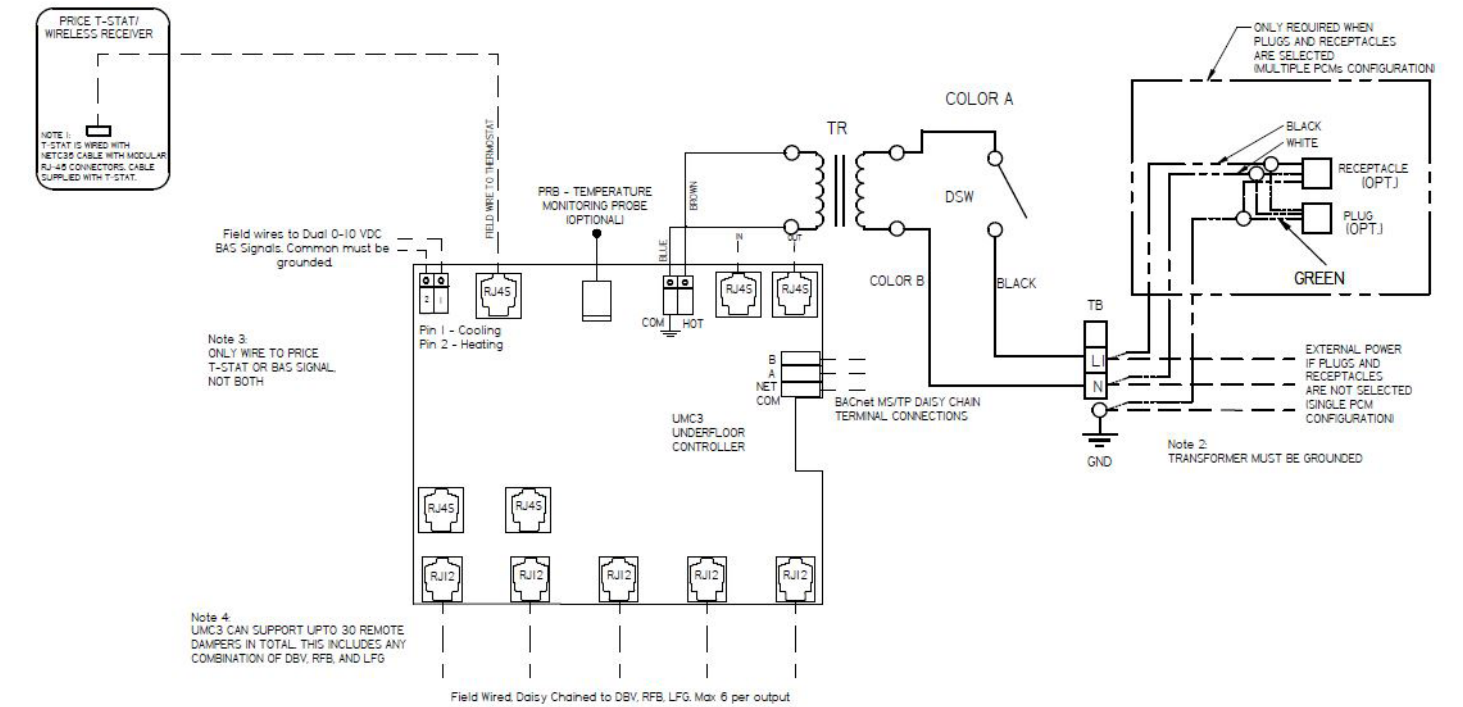

LEGEND	
---	C25 PLENUM CABLE
----	NETC35 PLENUM CABLE
—	FACTORY ELECTRICAL WIRING
- - - -	FIELD ELECTRICAL WIRING

Sequence of Operation -- Variable Cooling (DBV, RFB, LFG)

Cooling: When the room temperature increases above the room set point, all floor diffuser dampers modulate between the preselected minimum and maximum positions to meet room demand.

Heating: When the room temperature decreases below the room set point, all floor diffuser dampers remain at the preselected minimum position to prevent overcooling of the room.

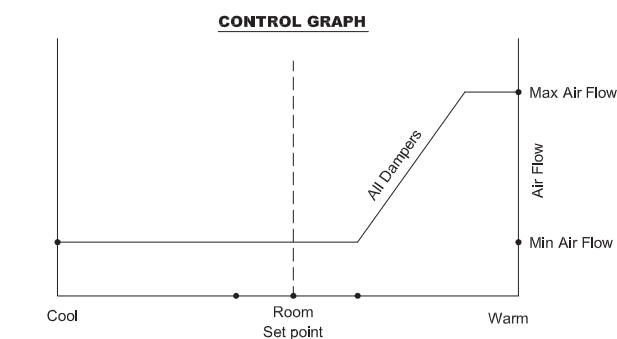

PCM - INTERIOR AND PERIMETER ZONES COOLING AND HEATING

INSTALLATION & MOUNTING INSTRUCTIONS

Thermostat Installation

General Description

The PCM Thermostats are all physically the same size and mounting instructions will be typical.

Location

1. The Third-Generation Underfloor ModuFlex Controller (PCM) Thermostats must be mounted to a wall and wired to the controller via the supplied plenum rated via the supplied plenum rated CFLEX cable. This cable plugs into the thermostat and the PCM controller with the ease of RJ-45 connections.

NOTE: The cable run can be extended to 70 ft. using a Price cable coupler and additional 35 ft. cable.

2. Mount the required thermostat in a place that is convenient for the end user, but the following should be taken into consideration:

- Do not mount a thermostat in direct sunlight i.e. across from a window where heat can alter the temperature reading.
- Should not be installed on an outside wall.
- Keep away from hot equipment like computers, monitors and heaters etc.
- Ensure nothing will restrict vertical air circulation to the thermostat. (Do Not Cover)
- Ensure wall is NOT pressurized! Hot/Cold air from a pressurized wall will blow directly onto the thermostat's temperature sensor causing inaccurate readings.

Installation

1. The back plate on each thermostat is removable and can be mounted to a standard electrical box or directly to drywall using anchors supplied by others.
2. Run the CAT-5 cable through the center hole in the plate and connect the cable to the thermostat. Then, secure the thermostat onto the wall plate by inserting the top portion of the thermostat first, then snapping the bottom half in.
3. All thermostats will come equipped with a 0.050 in. Allen Key for the set screw at the bottom.

TECH TIP ▼

Careful thermostat installation will reduce field issues! Do not twist or kink the blue CAT-5 thermostat cable. Damaged cables are difficult to troubleshoot!

Thermostat cable product code: C25 Cable

PLENUM RATED CFLEX CABLE INCLUDED ▼



SURFACE MOUNT DETAIL ▼

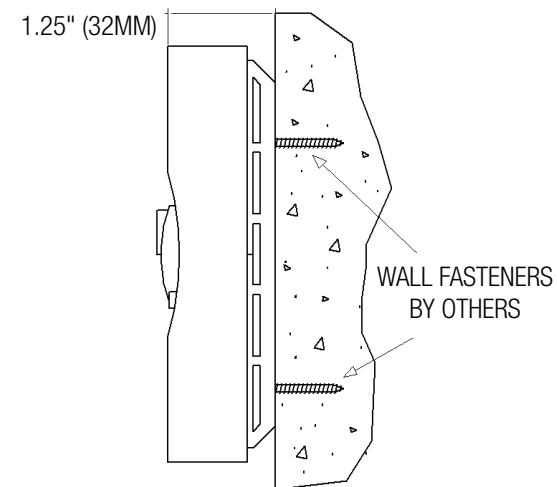

PCM - INTERIOR AND PERIMETER ZONES COOLING AND HEATING

INSTALLATION & MOUNTING INSTRUCTIONS

How to use Thermostats

Room Sensor Thermostat

- Measures room temperature.
- Setpoint can be adjusted from a hidden dial on the back of the thermostat using a small flat-head screw driver.
- Setpoint limits can be adjusted through free setup software using the Price LINKER, or through a BACnet system.
- Eliminated problem of unauthorized tampering with the thermostat.
- Occupancy button can be used to override the system during unoccupied times. Default setting is 4 hours.

Dial & Wireless Thermostat

Dial Thermostat

- Measures room temperature and features a dial adjustment and an occupancy button.
- Temperature Setpoint limits can be adjusted through free setup software using the Price LINKER, or through a BACnet system.
- Simply use the adjustable dial for temperature adjustment.
- Occupancy button can be used to override the system during unoccupied times. Default setting is 4 hours.
- LED light indicates what mode the thermostat is in. One blink is cooling mode, two blinks is heating mode, three blinks is neutral.

Wireless Thermostat

- Functionally identical to the Dial Thermostat.
- Requires wireless receiver, see Wireless Thermostat manual for details on installation.

LCD Thermostat

- Measures room temperature and features an LCD screen with push button day Setpoint adjustment.
- Temperature Setpoint limits are set through the thermostat setup menus, free setup software using the Price LINKER, or through a BACnet system.
- Balancing and additional setup functions also available through the menus.
- [Optional]: Add CO2 and humidity measurement with PIC-TS-CO2H

LCD Thermostat with Motion Sensor

- This model measures room temperature, features an LCD screen with day Setpoint adjustment, and motion sensor with lighting control.
- Temperature Setpoint limits are set through the thermostat setup menus, free setup software using the Price LINKER, or through a BACnet system.
- Balancing and additional setup functions are also available through the menus.
- This model is equipped with a motion sensor to determine occupancy of the space. This sensor can also be used to control lighting.

NOTE: All Price Thermostats are powered via the RJ-45 connection to the controller

ROOM SENSOR THERMOSTAT ▼



DIAL & WIRELESS THERMOSTAT ▼



LCD THERMOSTAT ▼



LCD THERMOSTAT W/ SENSOR ▼



PCM - INTERIOR AND PERIMETER ZONES COOLING AND HEATING

DISPLAY NAVIGATION

Initial Startup

(LCD & Motion Thermostat only)

When the LCD thermostat is powered from the PCM, it will display the following information:

PRICE ELECTRONICS	Start-up screen
LCD THERMOSTAT STANDARD MODEL	Standard/Motion Model
LCD THERMOSTAT VERSION X.XX	Displays firmware version of thermostat
LOADING: INITIALIZING	Loading parameters
PCM VERSION X.XX	Controller type and controller firmware version
SEQUENCE XXXX	Displays sequence programmed into stat NOTE: a sequence number of 0 means the stat has NOT been calibrated
MAC ADDRESS XXX	Displays current MAC Address
DEVICE INST. XXXXXX	Displays current Device Instance
ROOM TEMP. 75.0°F	(For example)



Changing the Setpoint – LCD & Motion Thermostat only

Day Setpoint Adjustment. Increase and decrease push buttons for Day Setpoint adjustment

DAY SETPOINT
75.0°F

DAY SETPOINT
SAVING...

PCM - INTERIOR AND PERIMETER ZONES COOLING AND HEATING

DISPLAY NAVIGATION

Service Menu

(LCD & Motion Thermostat only)

The Service menu allows the balancer/installer to access to the controller setup to change settings. For example setting flows, heating outputs, etc.

Hold 'Enter Menu' button for 5 seconds. Display will show '**Passcode:**'

Use 'Up' and 'Down' buttons to enter this passcode: **Down - Up - Up - Down.**

BALANCING	<ul style="list-style-type: none"> Allows you to force damper open/close/min/max
VVT	<ul style="list-style-type: none"> Allows you to set limits (%) in VVT mode
SETPOINT	<ul style="list-style-type: none"> Setup of Setpoint limits (day minimum/maximum) °F / °C selection
INPUT	<ul style="list-style-type: none"> Shows thermistor reading Allows setting of HCCO if desired
OUTPUT	<ul style="list-style-type: none"> Allows setup of auxiliary binary and analog outputs Allows setup of room light output (motion stat only)
ADDRESS	<ul style="list-style-type: none"> Allows setup of BACnet addresses MAC address, Device Instance Baud Rate
STAT SETUP	<ul style="list-style-type: none"> Allows setup of LCD back lighting, sounds, motion sensor Adjustment of HVAC and room lighting timeouts
PRESS MENU TO EXIT	<ul style="list-style-type: none"> This will exit the Service Menu if you press the Enter/Menu button NOTE: Service menu will automatically time out after 20 seconds

PCM - INTERIOR AND PERIMETER ZONES COOLING AND HEATING

DISPLAY NAVIGATION

Balancing Menu

Scroll through with the 'Up' and 'Down' buttons. Press 'Enter/Menu' button to apply your changes. '...Saving...' will display as your changes are applied.

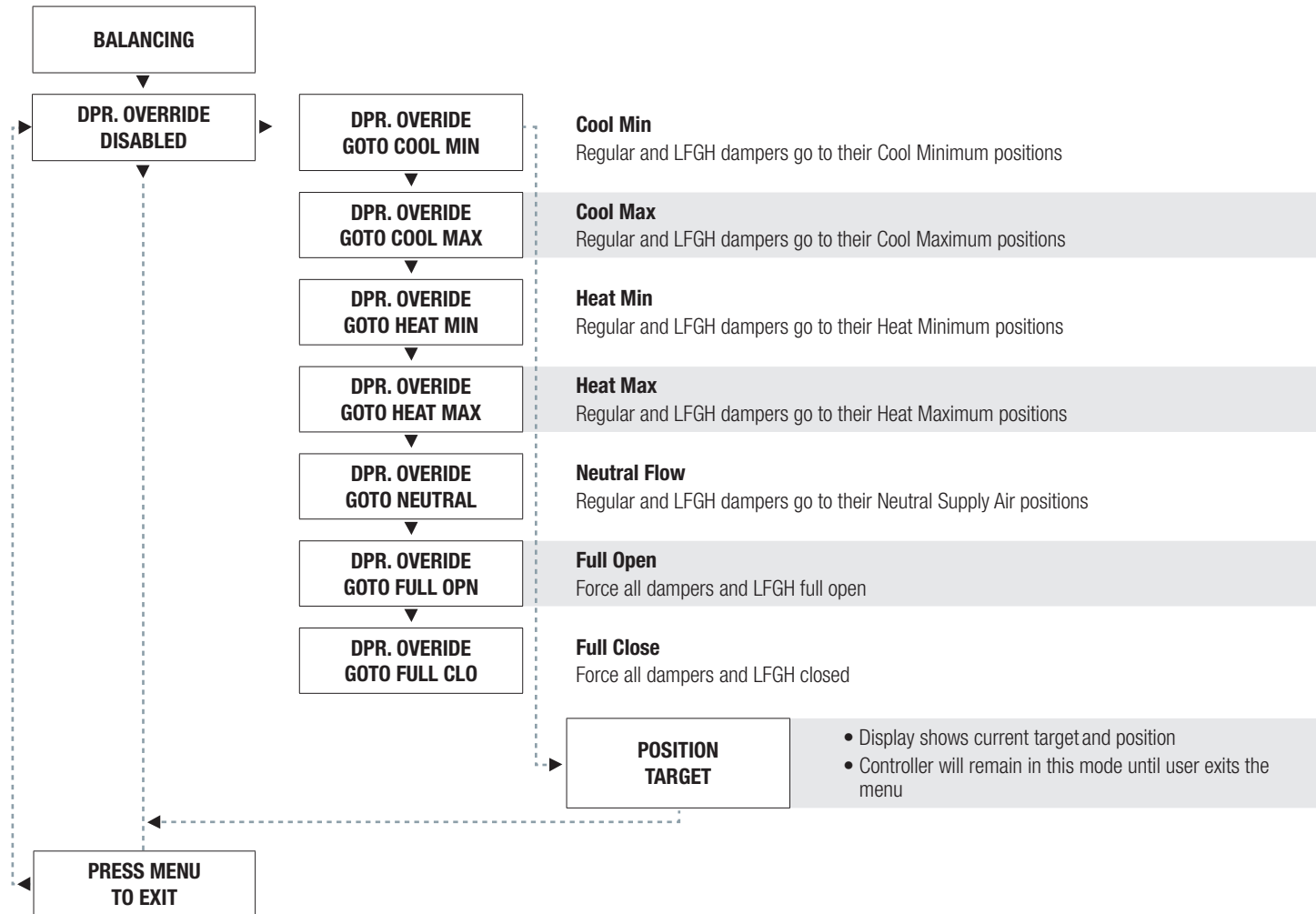

PCM - INTERIOR AND PERIMETER ZONES COOLING AND HEATING

DISPLAY NAVIGATION

VVT Menu

(Pressure Dependent Damper Ranges)

Scroll through with the 'Up' and 'Down' buttons. Press 'Enter/Menu' button to apply your changes. 'Saving...' will display as your changes are applied.

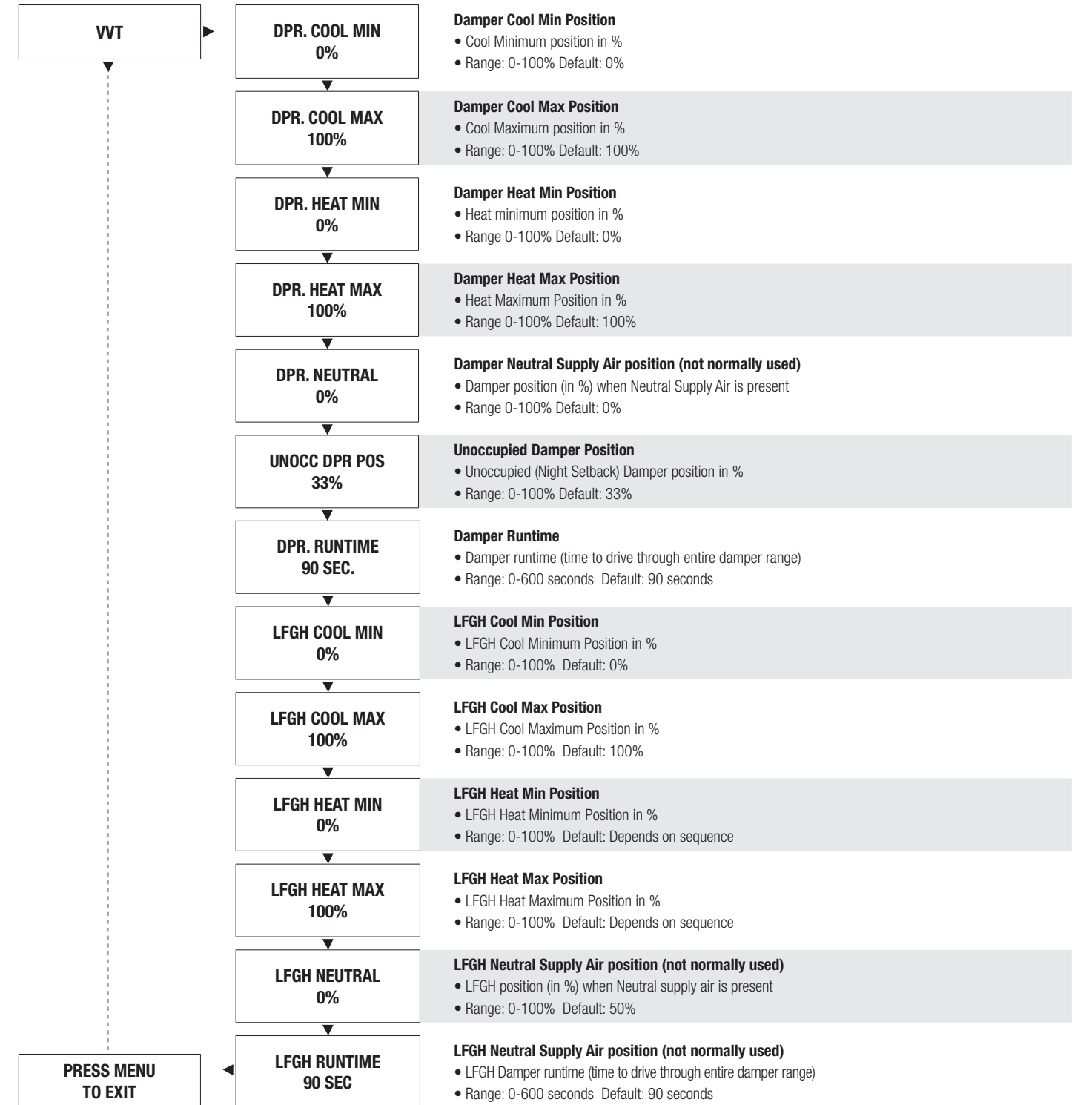

PCM - INTERIOR AND PERIMETER ZONES COOLING AND HEATING

DISPLAY NAVIGATION

Setpoint Menu

(Setpoint Limits and Temperature Units)

Scroll through with the 'Up' and 'Down' buttons. Press 'Enter/Menu' button to apply your changes. 'Saving...' will display as your changes are applied.

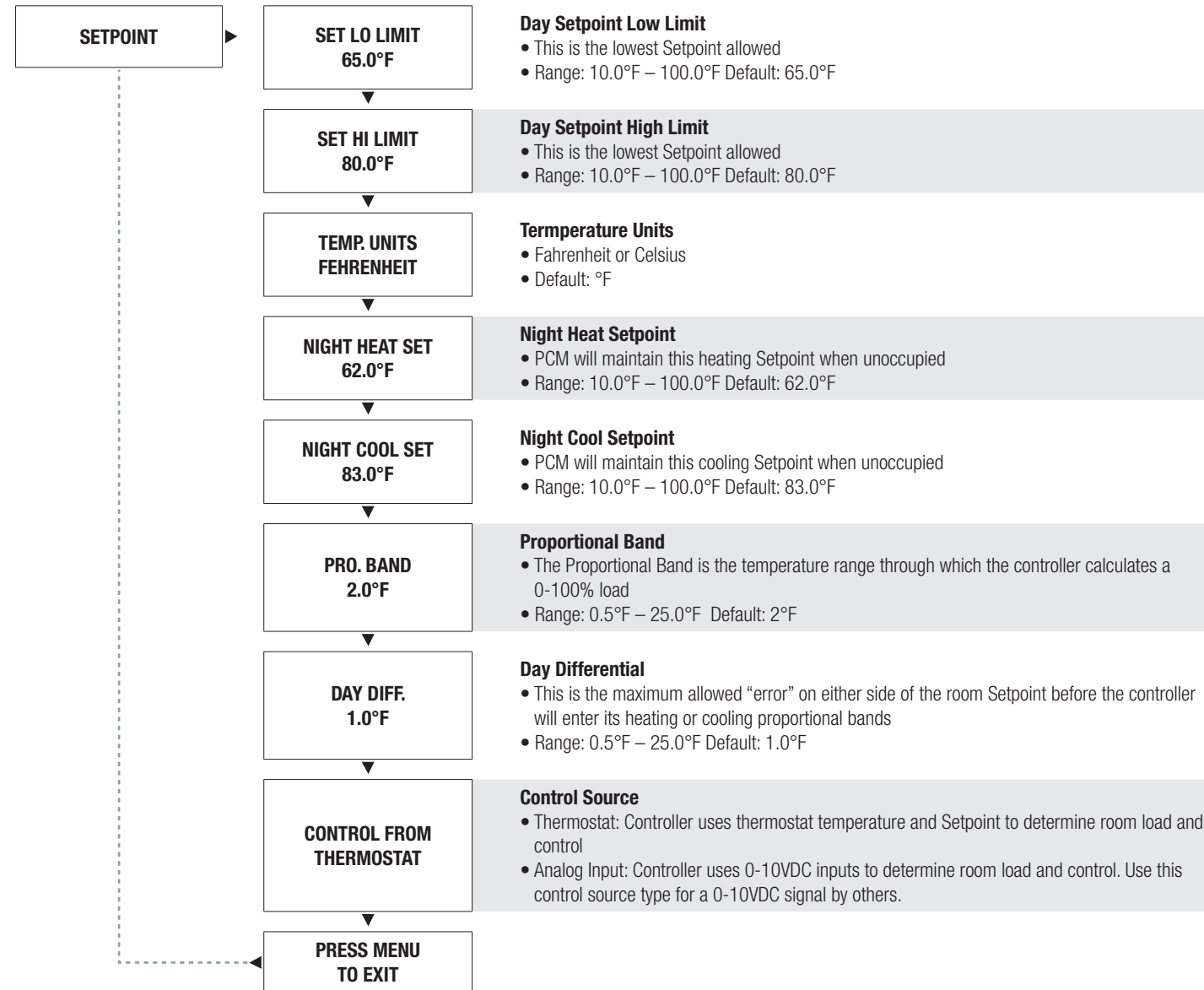

PCM - INTERIOR AND PERIMETER ZONES COOLING AND HEATING

DISPLAY NAVIGATION

Input Menu

(Supply Air Temp and Neutral Mode)

Scroll through with the 'Up' and 'Down' buttons. Press 'Enter Menu' button to apply your changes. 'Saving...' will display as your changes are applied.

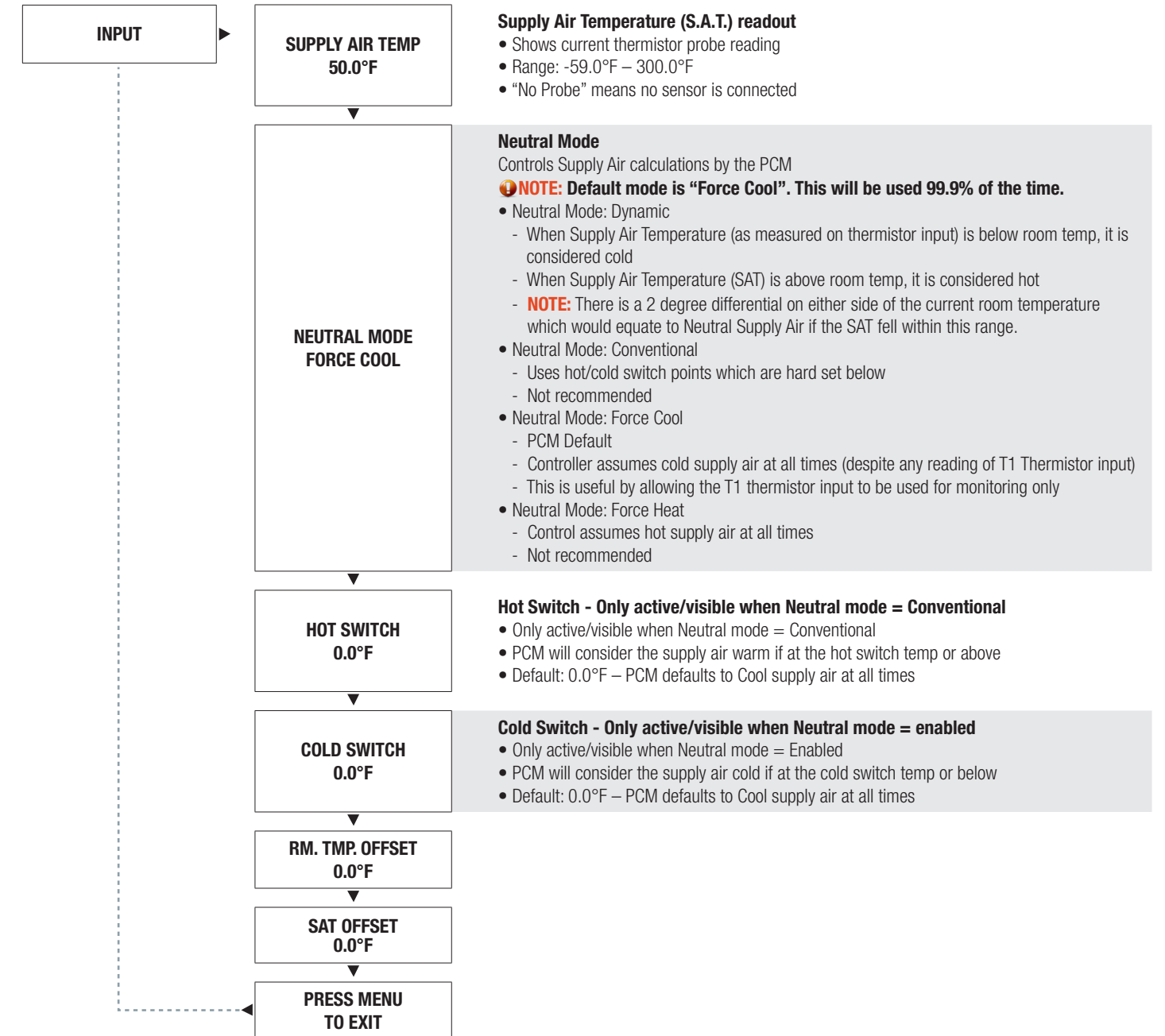

PCM - INTERIOR AND PERIMETER ZONES COOLING AND HEATING

DISPLAY NAVIGATION

Output Menu - Aux Binary

(Setup of Auxiliary Binary Output)

Scroll through with the 'Up' and 'Down' buttons. Press 'Enter Menu' button to apply your changes. 'Saving...' will display as your changes are applied.

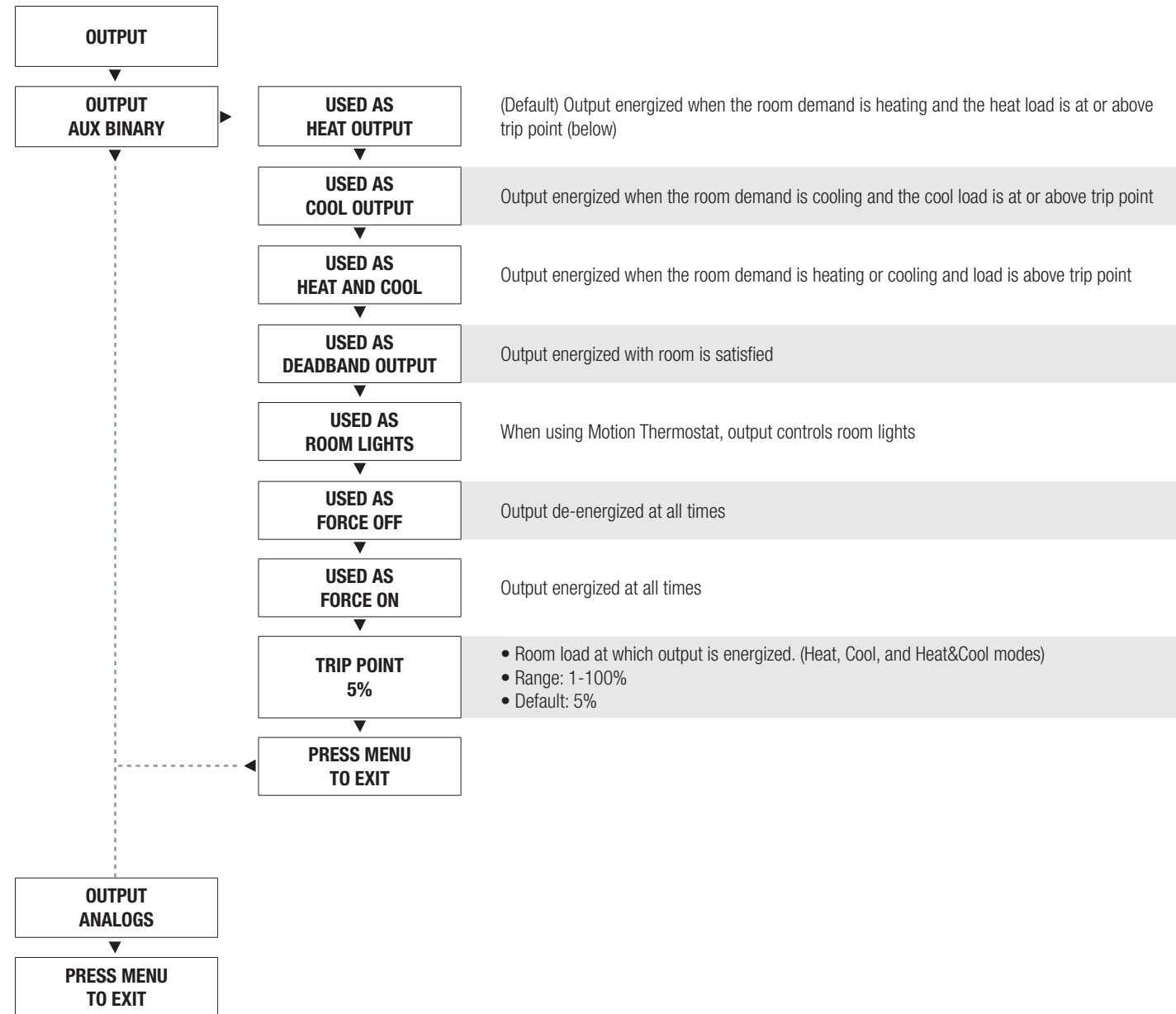

PCM - INTERIOR AND PERIMETER ZONES COOLING AND HEATING

DISPLAY NAVIGATION

Output Menu - Analog Outputs

(Setup of Analog Outputs)

Scroll through with the 'Up' and 'Down' buttons. Press 'Enter Menu' button to apply your changes. 'Saving...' will display as your changes are applied.

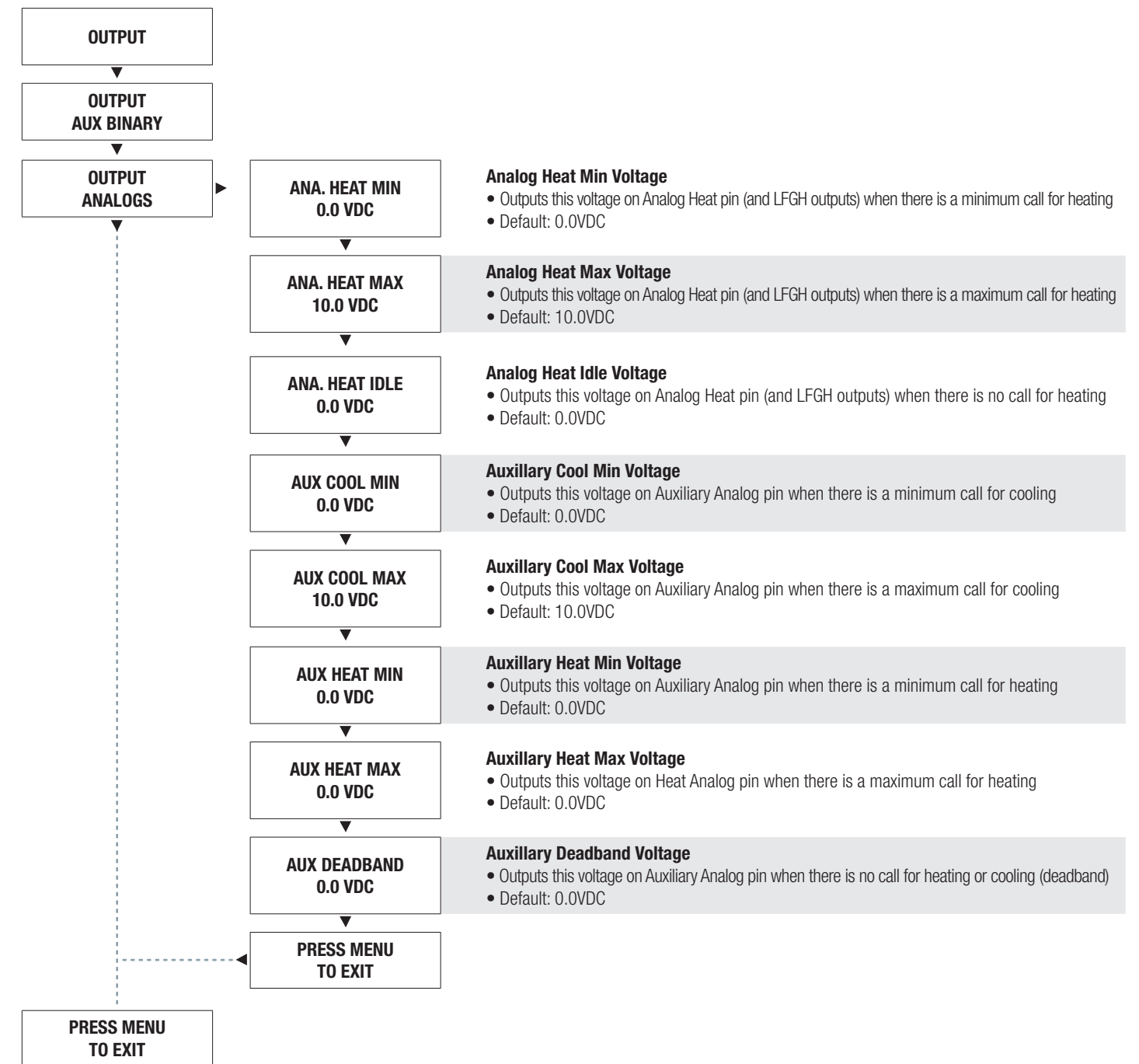

PCM - INTERIOR AND PERIMETER ZONES COOLING AND HEATING

DISPLAY NAVIGATION

Stat Setup Menu

(Stat Options)

Scroll through with the 'Up' and 'Down' buttons. Press 'Enter/Menu' button to apply your changes. 'Saving...' will display as your changes are applied.

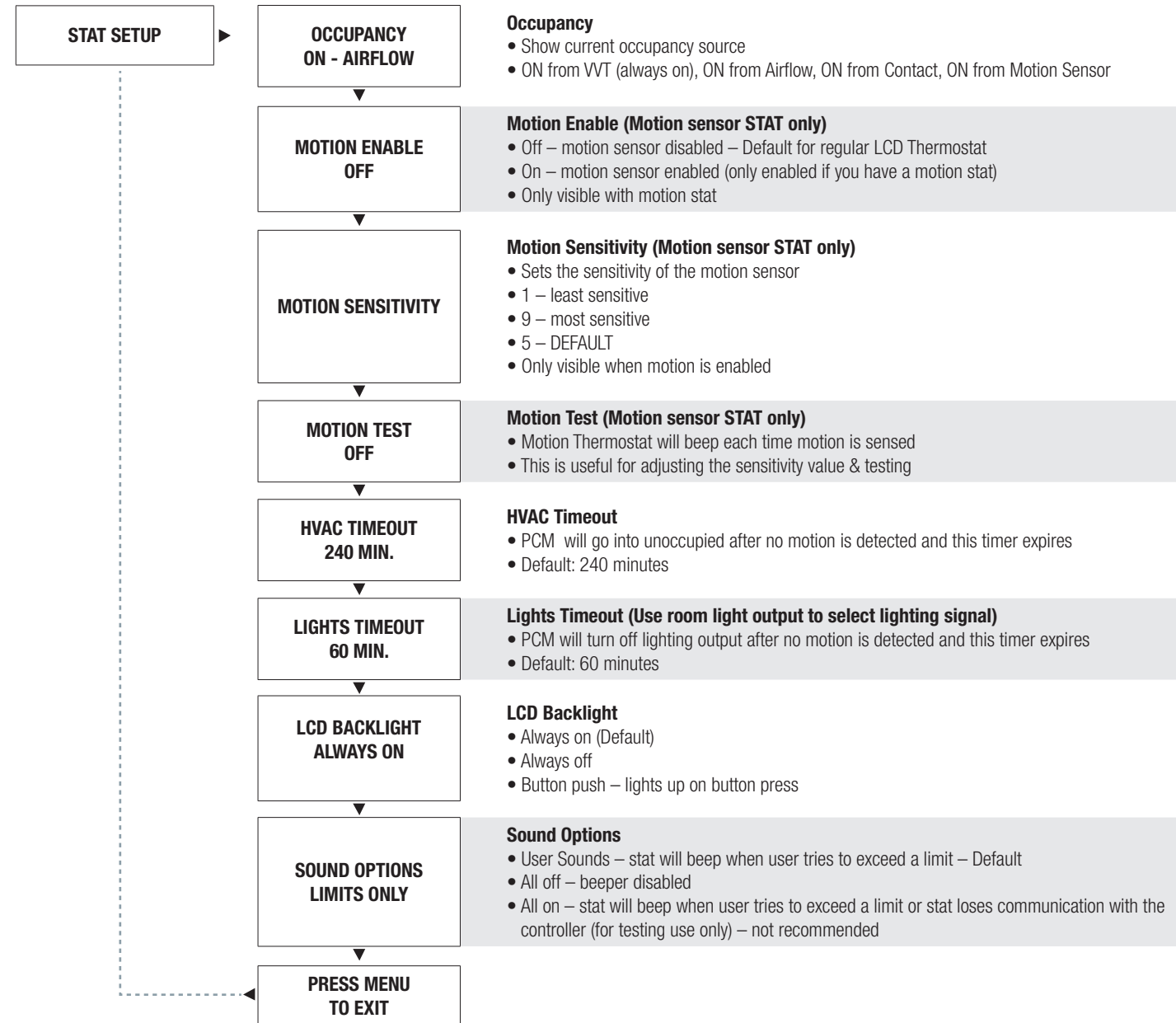

PCM - INTERIOR AND PERIMETER ZONES COOLING AND HEATING

DISPLAY NAVIGATION

Info Menu

(LCD & Motion Thermostat only)

The Info menu shows information about the controller status regarding room load, damper position and BACnet Address info. No values can be changed from this menu and it is not locked or protected in any way.

Press 'Enter/Menu' button to enter the User Menu, scroll through using the 'Up' and 'Down' buttons.

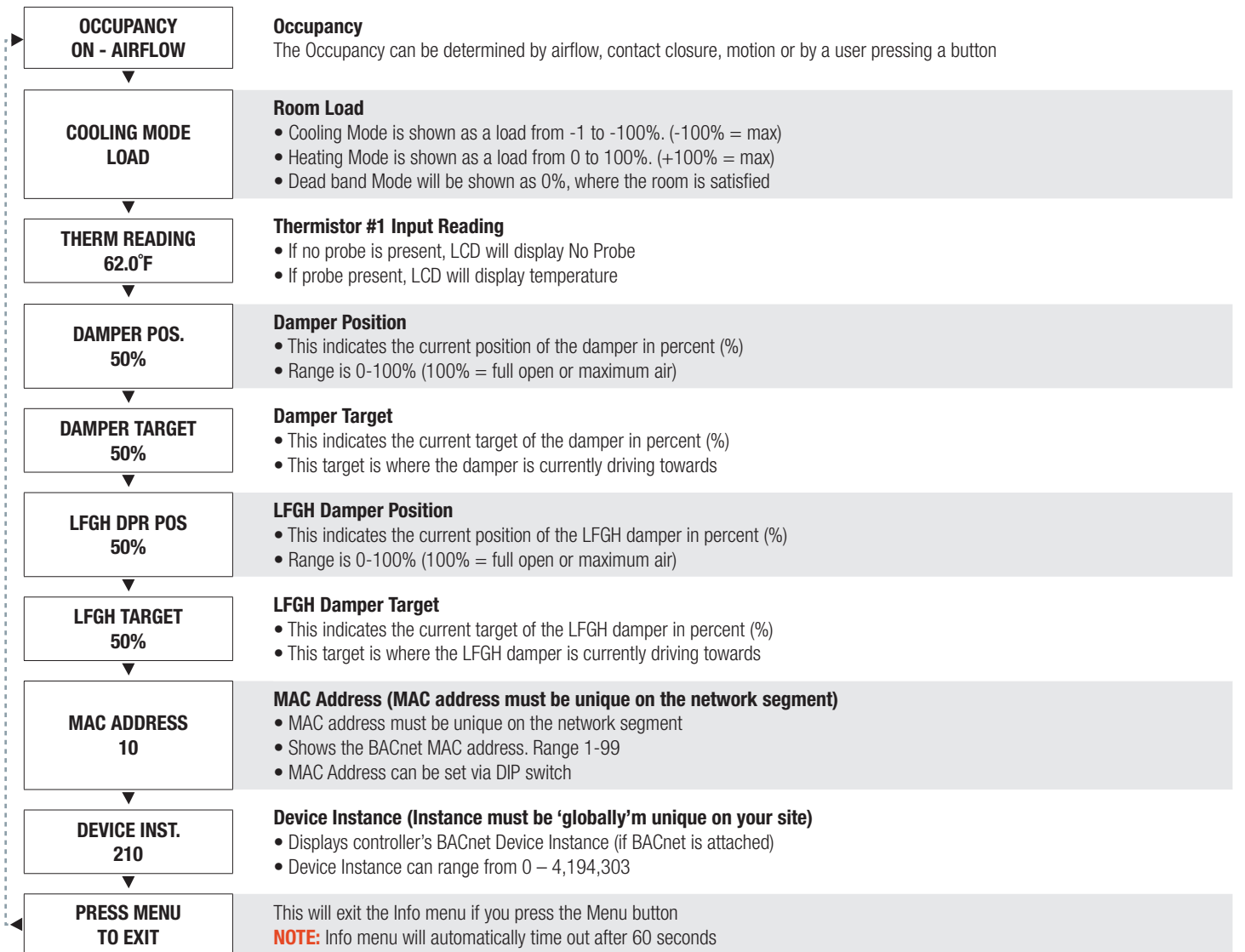

PCM - INTERIOR AND PERIMETER ZONES COOLING AND HEATING

DISPLAY NAVIGATION

Address Menu

(BACnet Addressing Setup)

Scroll through with the 'Up' and 'Down' buttons. Press 'Enter/Menu' button to apply your changes. 'Saving...' will display as your changes are applied.

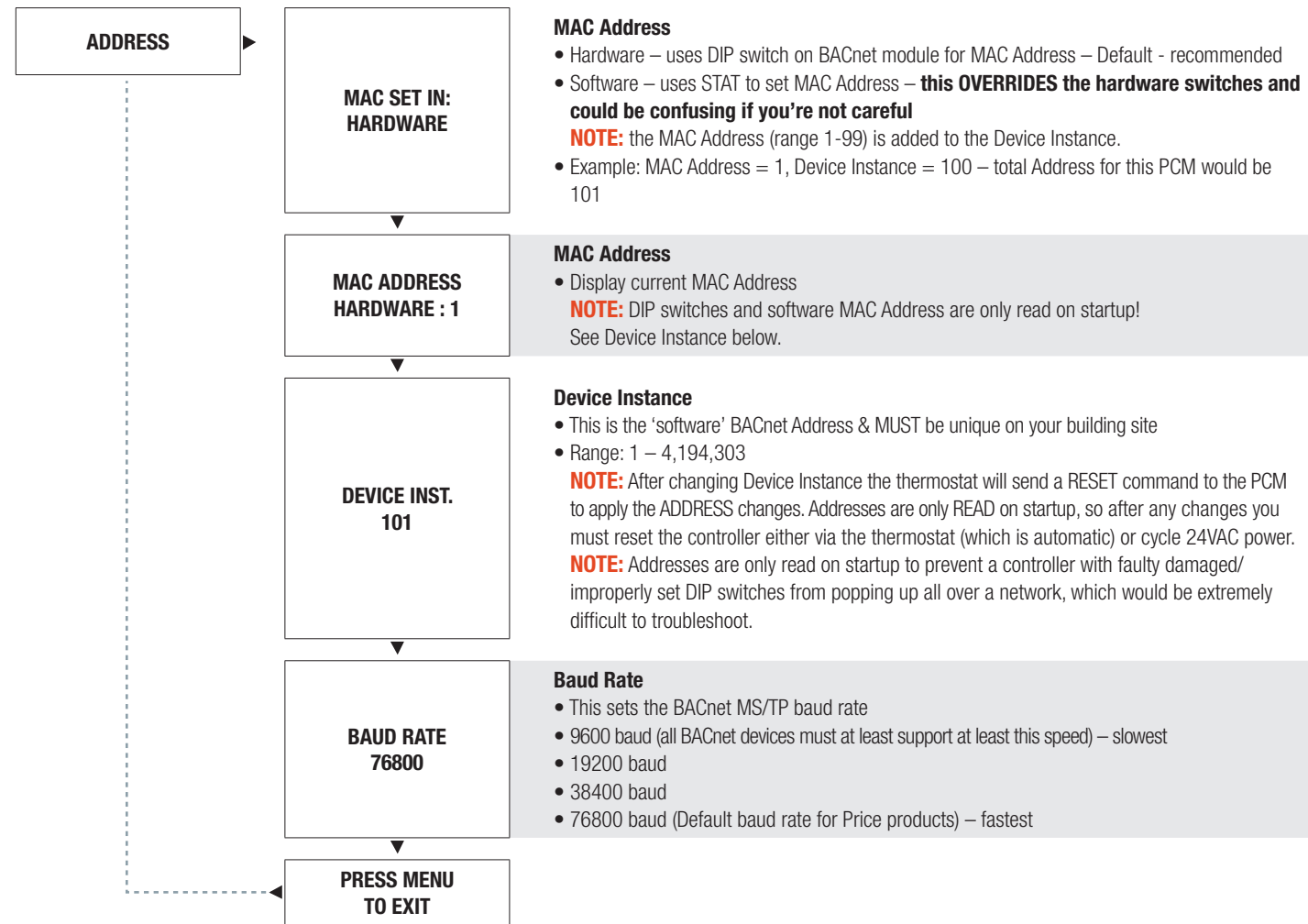

PCM - INTERIOR AND PERIMETER ZONES COOLING AND HEATING

NETWORKING & SETUP

BACnet Wiring

Price controllers, when selected with the optional BACnet interface, have the option of using supplied 35' CAT 5 cables to run BACnet MS/TP, or field supplied cable hardwired into a pluggable terminal block (see next page if using hardwired BACnet connections). The RJ-45 jacks for use with the supplied BACnet cables are directly tied to the pluggable terminal block, and so any combination of supplied cables and hardwired connections can be used on a single network segment.

BACnet networks must be run in a daisy chain configuration, meaning there is only one main cable and each network device is connected directly along its path, with no more than 30 devices per segment, and MS/TP segment lengths must not exceed 1050 feet.

Termination

BACnet MS/TP networks must be terminated to ensure proper operation. A network should be terminated twice, once at the beginning and once at the end. Termination helps reduce reflections and noise. The terminating can be done with a 100 ohm resistor across the + and - lines. Most Price controllers have the option for enabling termination via a DIP switch #8 or by a software menu selection. Turning on termination via software will enable the resistor across the lines and also turn on a green LED labeled "TRM".

Tech Tip: The Price BACnet MS/TP to IP Router has built in termination and it is enabled by default (since the router is typically the beginning of the entire MS/TP network). Now you only have to go and find/terminate that last device.

Electrical Noise

Electrical noise can affect both analog signal and digital communications such as BACnet. Therefore do not route high voltage lines next to the BACnet network! Avoid noisy electrical sources such as:

- Variable Frequency Drives
- High current power lines (main panel feeds)
- Fluorescent light fixtures

If you must pass near noisy electrical lines cross at right angles. This will help reduce the amount of noise coupled to the network wires.

BACNET WIRING

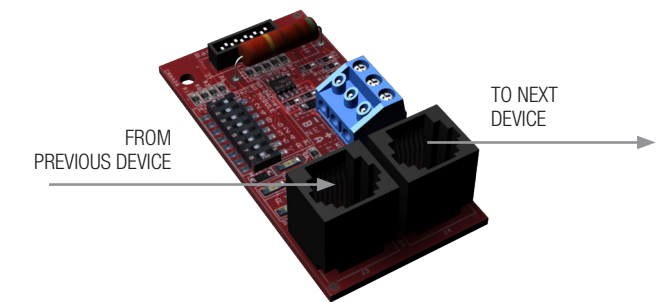

ELECTRICAL NOISE EXAMPLE

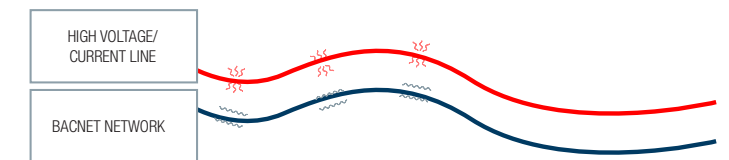

PCM - INTERIOR AND PERIMETER ZONES COOLING AND HEATING

NETWORKING & SETUP

Use Price supplied CAT-5 cables for BACnet whenever possible. If not possible to use Price supplied cables, follow these wire specifications.

Network Wire Specifications

For the BACnet MS/TP network specific wire is required. Do not use standard power or “thermostat” wire. This wire does not have the necessary requirements for digital communications. While it’s possible it may work (temporarily) the network will be unreliable and not operating at optimal.









BACnet MS/TP Wire type recommendations

- Use 1 balanced twisted pair
- Low capacitance (17pF or less)
- Plenum rated (FT6, CMP ratings)
- 100-120 ohm, Balanced
- (CAT5, CAT5E, CAT6 network cable has excellent specifications and will work in almost any BACnet MS/TP application.)
- **Price recommends using the Orange Complement for (+), the Orange for (-), and the Brown and Brown Complement for the (NET COM) connections. These are paired in a standard CAT5E cable.** Pre-terminated CAT5 cables are available from Price. Model code: NETC35 (35 ft plenum rated cable, terminated with RJ45 plugs, 568-B standard)

NOTE: NETCOM MUST BE WIRED



WIRING ▼

	T568B Color
PIN 1	 white/orange stripe
PIN 2	 orange solid
PIN 3	 white/green stripe
PIN 4	 blue solid
PIN 5	 white/blue stripe
PIN 6	 green solid
PIN 7	 white/brown stripe
PIN 8	 brown solid

PCM - INTERIOR AND PERIMETER ZONES COOLING AND HEATING

NETWORKING & SETUP

BACnet Service Menu

Each controller’s MAC address, Device Instance, and Baud rate are set in the BACnet sub-menu of the service menu accessed through an LCD thermostat or LCD setup tool. For information on how to select a MAC address and Device instance for any controller on a network, see following pages.

To set the controller’s BACnet settings, enter the **Service Menu** and adjust settings as follows:

NOTE: When the screen displays a flashing value, that value is ready to be changed and can be adjusted by pressing the arrow keys. Pressing Menu will save the value.



SERVICE MENU:
APPLICATION



SERVICE MENU:
BACNET





MAC SET IN:
HARDWARE



MAC ADDRESS:
SOFTWARE 0



Hold down the **Menu** button on the LCD Thermostat for **5 seconds** until prompted for a passcode; use  and  to enter the passcode; **DOWN, UP, UP, DOWN.**

The screen will now display “Service Menu: Application.”

Scroll down to the BACnet sub-menu.

Press the **Menu** button to enter this menu.

Screen will now show ‘MAC set in Hardware’, this is a default setting that means the physical DIP switched on the BACnet board must be set to set the MAC address. For easier setup, Price recommends setting the MAC over software which will override the DIP switch settings.

Use the up arrow to scroll to whatever MAC you are intending to set this controller to, once you arrive at the number, press Menu to save

PCM - INTERIOR AND PERIMETER ZONES COOLING AND HEATING

NETWORKING & SETUP



The device instance defaults to 100, but will be displayed with the last 2 digits as the MAC if the previous screen was set to enabled. Press Menu then use the arrow keys to change the device instance.

NOTE: Each Menu press will change allow changes in different tiers of the device instance (so that you don't have to scroll for extended periods to get into the millions range – supposing that's where you need to set your device instance)



The baud rate is the speed that the MS/TP network runs at. EVERY device on the network must run at the same speed. Price controllers are defaulted to a baud rate of 76800, but can be changed to 38400, 19200, or 9600. For a network segment with all Price controllers (including Price PRTU systems), it's recommended that the baud rate be left at 76800.

*Choose lower baud rates only when integrating with devices by other manufacturers whose maximum speed is lower than 76800 (eg. 38400).

Once all settings are made, scroll down to press Menu to exit, and press Menu. The controller will then re-start, this is because all BACnet info is only read once at startup. If you had left the MAC set in hardware, and adjusted the DIP switch settings to set the MAC address, you would have to manually restart the controller by cycling 24 VAC power for the new MAC address to take effect (setting through software makes the restart happen automatically however).

PCM - INTERIOR AND PERIMETER ZONES COOLING AND HEATING

NETWORKING & SETUP

BACnet Networking and Setup

Setting the MAC Address:

MAC (media access control) must be UNIQUE on an MS/TP network segment within building. An installer setting up an MS/TP segment must ensure each device has a UNIQUE MAC Address (Range 1-99). The MAC Address is set through the LCD thermostat or LCD setup tool.

NOTE: Each device on a network segment must be set to run at the same speed or baud rate.

NETWORK SEGMENT #1 ▼

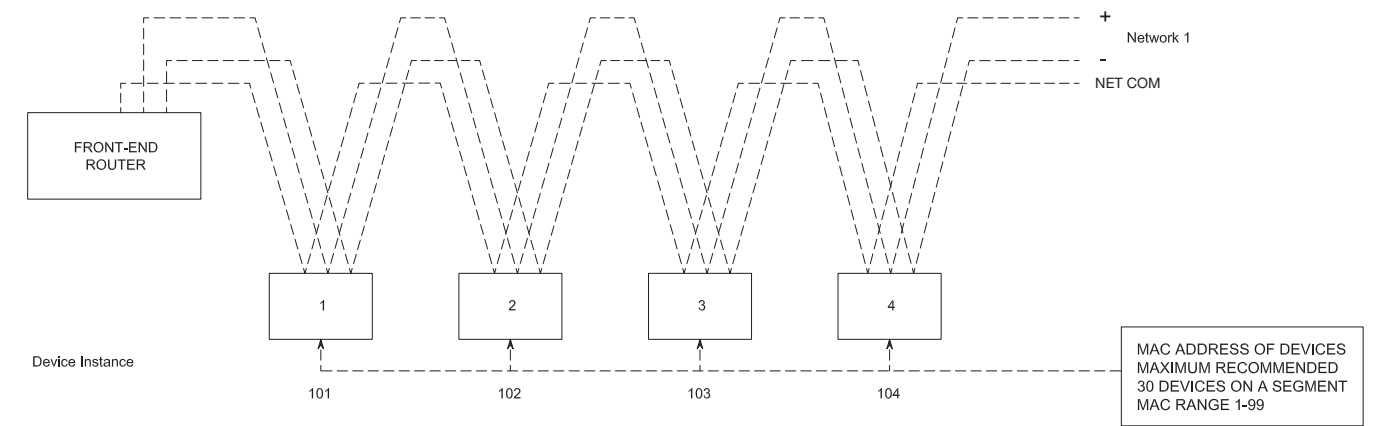

NETWORK SEGMENT #2 ▼

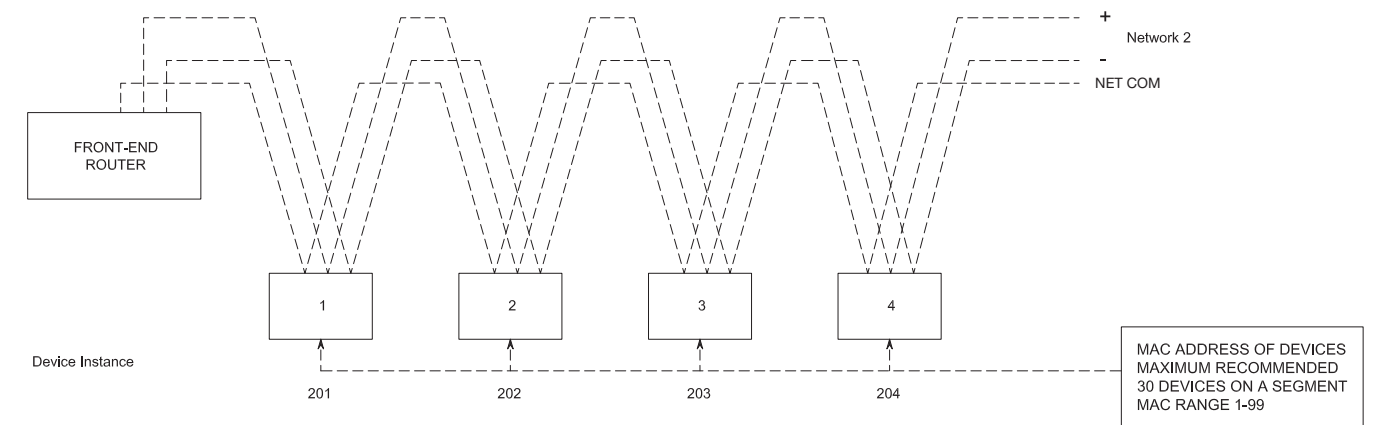

TECH TIP ▼

24 VAC power HOT and COMMON polarities are critical and must not be reversed on ANY devices! Reverse polarity will stop communication on that MS/TP segment. All 24 VAC transformers must be grounded on their secondary side for BACnet to work.

NET COM wire must be connected at each device and is critical for BACnet network reliability. Use one twisted pair for + and -, and another twisted pair for NET COM for optimal noise cancellation.

PCM - INTERIOR AND PERIMETER ZONES COOLING AND HEATING

NETWORKING & SETUP

Setting the Device Instance

Device Instance:

A Device Instance number identifies a device within an entire building, therefore giving it a unique number or Address, much like a telephone ext. number. A building can have one telephone number, but all the extensions have a unique number to identify them. A Device Instance number would work the same way and must be unique throughout the building. The Device Instance number is user set through the LCD Thermostat or LCD setup tool.

Below is a table defining how a Device Instance number is obtained.

NOTE: Each device on a network segment must be set to run at the same speed or baud rate.

Description	Default Value (Factory)	Notes
MAC Address	6	Value: limited to 1-99
Tier 1 (x100)	58	Value: limited to 0-99
Tier 2 (x10,000)	1	Value: limited to 0-99
Tier 3 (x1,000,000)	0	Value: limited to 0-4

Example Device Instance setup with Default settings:

- MAC Address = 6 (6 x 1 = 6) – Set through software

+

TIER 1 = 58 (58 x 100 = 5800) – Set through software

+

TIER 2 = 1 (1 x 10,000 = 10,000) – Set through software

+

TIER 3 = 0 (0 x 1,000,000 = 1,000,000) – Set through software

=

Final Device Instance = 0,015,806



LCD-SETUP ▼



i TECH TIP ▼

When using a controller with a DIAL thermostat, the you must purchase a setup tool in AIO known as LCD-SETUP and use this to configure the controller. Remember, all settings are stored in the PIC controller and not the thermostat.

PCM - INTERIOR AND PERIMETER ZONES COOLING AND HEATING

NETWORKING & SETUP

LINKER - USB Service Tool

The Price USB LINKER is the interface that can be used with any of the Price Thermostat for the PCMB. The LINKER connects to a laptop (not supplied) via a USB A to B cable supplied by Price, and then connects to the service jack of the thermostat via an RJ-12 cable supplied by Price. Setup of the controller can then be performed using the connected laptop.

LAPTOP CONNECTION ▼

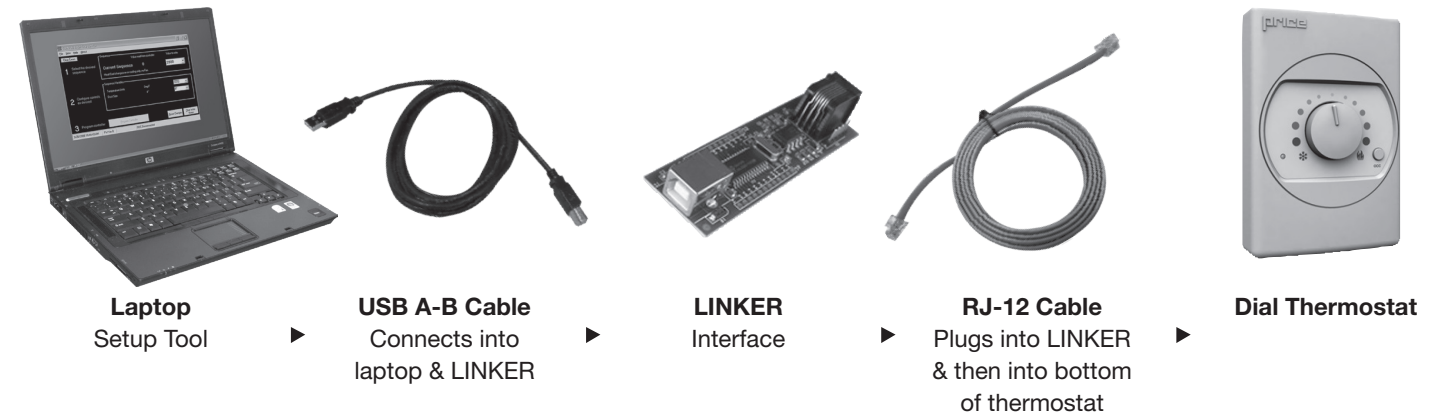

An LCD Thermostat can be purchased as an upgrade and used to perform setup/balancing instead of a laptop/LINKER Tool. The LCD Thermostat provides full functionality for system setup.

LCD CONNECTION ▼



PCM - INTERIOR AND PERIMETER ZONES COOLING AND HEATING

MAINTENANCE



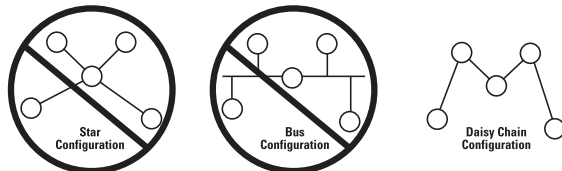

Troubleshooting

The following information is provided in the event that the PCM does not appear to function properly after installation.

Fault	Solution
Controller appears to be not responding or have no power. Green light on the controller is not blinking. Thermostat green indication light not on, or LCD screen is blank.	Check thermostat first for either green indication light, or LCD display. If either of these does not appear, then check the controller for power (green blinking light). If no power is present, check 24VAC power with a multimeter. Cycle power to the controller. If this doesn't restore power, check the power that is feeding that controller for your problem.
Dampers don't move, and red FAULT light is illuminated.	Red fault light means there is a short in the cable from CW/CCW to COM. Find shorted cable(s) in that string of dampers and replace.
Damper acts erratically	If the CW/CCW lines in the cable are shorted together (and not shorted to the COMMON), it could cause the dampers in a string to act erratically and drive in random directions. Find bad cable(s) in the string, and replace.
24 VAC Binary Outputs not functioning	Ensure that the controller has 24VAC power. Ensure that there is a call for heating or for cooling, room lights, etc. If so, check to see that the GREEN indication light is on for the output. The next step would be to check the device that is triggering the output like a relay. Ensure that the relay has engaged (pulled in) for either heating or cooling application. Check the output configuration
Analog Outputs not functioning	Ensure that the PCM has 24VAC power. Check the analog output for voltage with a multimeter. You should see a voltage in the range of 0-10VDC. Direct Acting Output – 0VDC indicates that the field device is closed or at a minimum position. 10VDC indicates that the field device is open or at a full open position. Direct Acting is typical with cooling applications. Reverse Acting Output – 0VDC indicates that the field device is fully opened or maximum position, and 10VDC indicates fully closed or minimum position. Reverse acting is typical with heating applications.
SAT Sensor Analog Input not functioning	Ensure that there is a sensor wired to the input on the PCM controller. Check the type of sensor, should be a 10k Ohm Type Thermistor.
BACnet Communication Errors	BACnet - MS/TP is based on a RS-485 network. It must be wired in a daisy chain configuration. A daisy chain means that there is only one main cable, and every network device is connected directly along its path.  DO NOT use Star, Bus, "T", or any other type of network configuration. Any of these other network configurations will result in an unreliable network, and make troubleshooting almost impossible. Correct polarity is imperative on MSTP wiring. Always ensure that the positive terminal on a device has the same color wire connected to it throughout the network, same for the negative terminal. Eg. 2 wire conductor with black and white wires – black to the positive terminal, and white to the negative terminal. Keep this consistency throughout the network.

PCM - INTERIOR AND PERIMETER ZONES COOLING AND HEATING

MAINTENANCE

Fault	Solution
BACnet Communication Errors 	Price does not use EOL or termination on their devices. Terminating a device is almost never required at the low baud rate of MS/TP devices. In fact terminating can create more problems than it solves. The network speed or baud rate must be the same throughout the network. NOTE: The default speed for Price BACnet MS/TP controls is 76800. BACnet MS/TP currently supports 4 standard speeds which are: 9600, 19200, 38400 and 76800.
BACnet Communication Errors 	Binary Address must be unique for each device on the network. No two devices can have the same Address. This includes if you are incorporating a Price product into an existing network. Determine the existing Addressing scheme for the existing network. The Address is set on the Addressable DIP switches on the PCM.
BACnet Communication Errors 	Grounding and 24VAC polarity: Proper grounding is absolutely essential when wiring the MS/TP BACnet Network. Proper grounding will prevent many potential problems that can occur in a network of devices. Common symptoms of a poorly grounded network can include inconsistent BACnet MS/TP communications and damage from voltage spikes. The most practical method of grounding is to ground every 24VAC transformer common/neutral used to power the controls. Connect the "common/neutral" wire of the SECONDARY side of the transformer to earth ground – such as the ground screw on in the electrical box.
BACnet Communication Errors 	NOTE: Flipping 24VAC HOT and COMMON will cause the BACnet MS/TP Network to stop communicating!!! Ensure HOT and COMMON are not reversed on ANY controllers. WARNING: Controllers will still power up and run even if HOT and COMMON are reversed. However output signals to other devices such as heaters, relays, etc will not work as intended!

Hardware Specifications

Power Requirements	24VAC, 47-63 Hz 6VA (not including output loading) NEC Class II
Ambient Ratings	32° to 131° F (0° to 55° C) 10 to 90% RH (non-condensing)
Outputs	24VAC Binary Output. Max 0.5Amps Analog 0-10 VDC (x2). Max: 10mA each - Heat, Aux Damper outputs - Connect up to 30 dampers
Inputs	Thermistor Sensor (10k Type J thermistor) Analog 0-10V inputs (x2). 20k ohm input impedance <ul style="list-style-type: none"> • Thermostat Inputs • Room Setpoint Dial • Temperature Sensor (10K Type J Thermistor) <ul style="list-style-type: none"> • Accuracy of +/- 0.5°F from 55°F to 85°F (+/- 0.25°C from 13°C to 25°C)
Communication ports	BACnet MS/TP Connection (optional) <ul style="list-style-type: none"> • Communication speeds: 9,600, 19,200, 38,400, 76,800 (default) • Maximum recommended devices per MS/TP segment: 30 LINKER port • For local setup using Price USB LINKER service tool
Enclosure Size	15.5 in. x 12.75 in. x 4 in.
Enclosure Weight	15 lbs. (6.8kg)

This document contains the most current product information as of this printing.
For the most up-to-date product information, please go to priceindustries.com

© 2024 Price Industries Limited. All rights reserved.



The Science of Comfort™